

Article number: 12318000160500
Description: KLEE-coil 318 000 160.500
M16 St. steel 1.4305 slotted pin

Measures

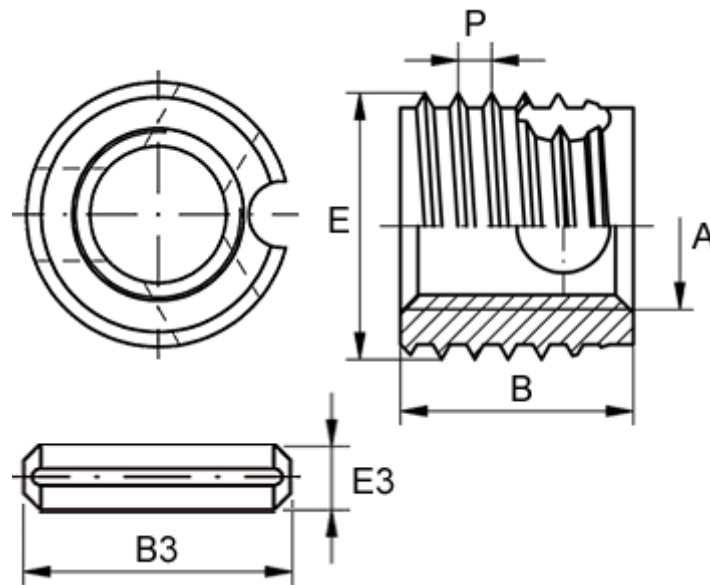

Female thread A	= M16
Length B	= 24
Male thread E	= 20.0
Min hole depth blind hole	= 28
Slotted pin B3	= 16
Slotted pin E3	= 2
Thread pitch P	= 2.00
Type	= 318 000 160 ...